

PUTCO 1999-2006 CHEVY/GMC (4 DOORS) #90011 LIQUID SOLID BILLET DOOR HANDLE INSTRUCTION SHEET

Congratulations on your purchase of a high quality PUTCO product. Should you need any application or technical assistance feel free to call us at: 1-800-247-3974 Monday-Friday 8:00 a.m.- 5:00 p.m. (Central Standard Time)
Contact your PUTCO dealer for other quality accessories.
PUTCO Inc. - 216 West First Street - Story City, Iowa 50248

PLEASE READ ALL INSTRUCTIONS BEFORE INSTALLATION AND TO CHECK TO SEE THAT ALL PARTS ARE INCLUDED.

The installation of the replacement door handles are for persons with advanced auto-body skills and is recommended to have them professionally installed.

Kit Contents

Item #	Quantity Reqd.	Description
1	4	Door Handles



Safety Tools	
Eye Protection	
Special Tools	
Masking Tape	
Torque Wrench	
Installation Tools	
Flat Head Screw Driver	
Philips Screw Driver	
Pliers	
Needle Nose Pliers	
10mm Socket	
Ratchet	

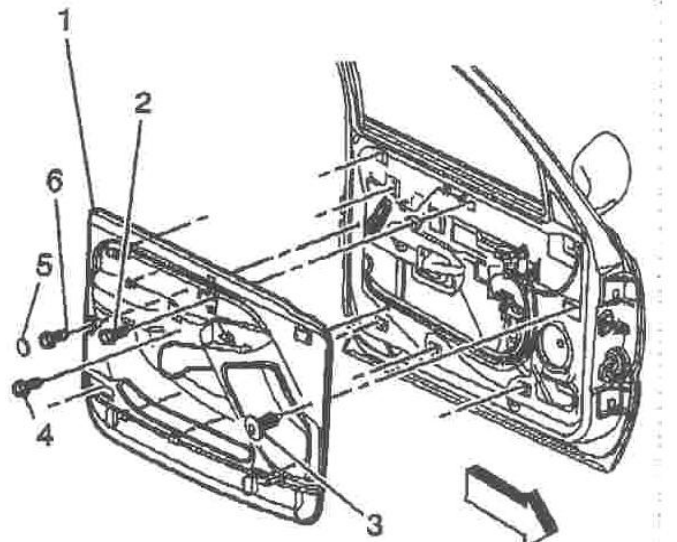











Fig. B-1

A. Pre-installation Preparation









-  **Step 1:** Verify kit contents.
-  **Step 2:** Remove protective wrapping from handles and place on a non-abrasive surface.
-  **Step 3:** Remove the door handles from the box.

PUTCO 1999-2006 CHEVY/GMC (4 DOORS) #90011 LIQUID SOLID BILLET DOOR HANDLE INSTRUCTION SHEET





B. Remove Door Paneling

-  **Step 1:** Use a flat bladed tool to gently pry the manual lock lever from the door panel. **Note: Use Figure B-1 as a guide to remove your door panel.**
-  **Step 2:** Remove the push in fastener at the front edge of the door trim. **Push fastener is labeled 3 in figure b-1**
-  **Step 3:** Remove the cap covering the screw on the rear edge of the trim panel. **(Labeled #5 in B-1)**
-  **Step 4:** Remove the trim panel screws depending on the year of your vehicle you may have two or three screws to remove. They are located at the door lock opening, armrest, and rear edge of you door panel. **Panel screws are numbers 2, 4, and 6 in figure b-1.**
-  **Step 5:** To remove your door panel carefully slide the panel up in order to release the retainers from the door.
-  **Step 6:** Disconnect the electrical connectors so your panel is free from the vehicle.

C. Remove Factory Door Handle

-  **Step 1:** To access the door handle you will need to peel back the water deflector just enough for you to access the door handle.
-  **Step 2:** Remove the outside handle rod from the rod clip.
-  **Step 3:** Remove the lock cylinder rod from the rod clip.
-  **Step 4:** You need to apply masking tape across the outside of the door handle to secure it while removing the nuts.
-  **Step 5:** Remove the outside handle mounting nuts.
-  **Step 6:** Remove the rubber cover to gain access to the outboard nut.
-  **Step 7:** Remove the door lock connecting rod from the lock cylinder clip.
-  **Step 8:** Remove the door handle.

D. Removal & Installation of Factory Lock (see figure d-1)

-  **Step 1:** Pull the clip that surrounds lock area off.
-  **Step 2:** You will now be able to remove your lock cylinder by pushing it through the backside of the door handle.
-  **Step 3:** Install your lock by placing the lock cylinder in the lock location the same way you removed it in step 2.
-  **Step 4:** Place the clip into the slots that surround the lock area.

PUTCO 1999-2006 CHEVY/GMC (4 DOORS) #90011

LIQUID SOLID BILLET DOOR HANDLE INSTRUCTION SHEET

Step 5: Test the lock to make sure it is in place and secure.

E. Installation of Replacement Door Handle

Step 1: Install your replacement door handle.
Note: On some vehicle applications, it is necessary to enlarge the mounting hole on the inside of the factory door opening for proper installation and centering.

Step 2: Install the lock cylinder clip to the lock cylinder rod.

Step 3: Install the handle rod to the handle assembly clip.

STOP **Step 3:** Install the outside handle mounting nuts.

! **IMPORTANT: DO NOT OVER TIGHTEN NUTS**

F. Install Door Paneling

Step 1: Install the rubber cover.

Step 2: Put the water deflector back in its place.

STOP **Step 3:** Install the door paneling

Repeat steps B through F for all remaining doors.

KEY FOR FIGURE B-1

- 1> Interior door panel
- 2, 4, &6> Interior panel screws
- 3> Interior panel push pin
- 5> interior screw cap cover for screw labeled 6

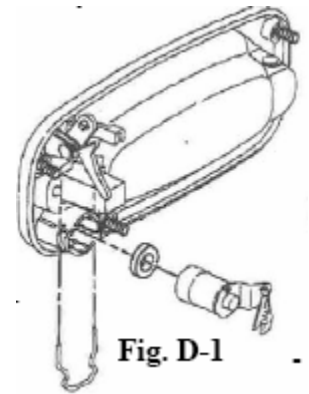
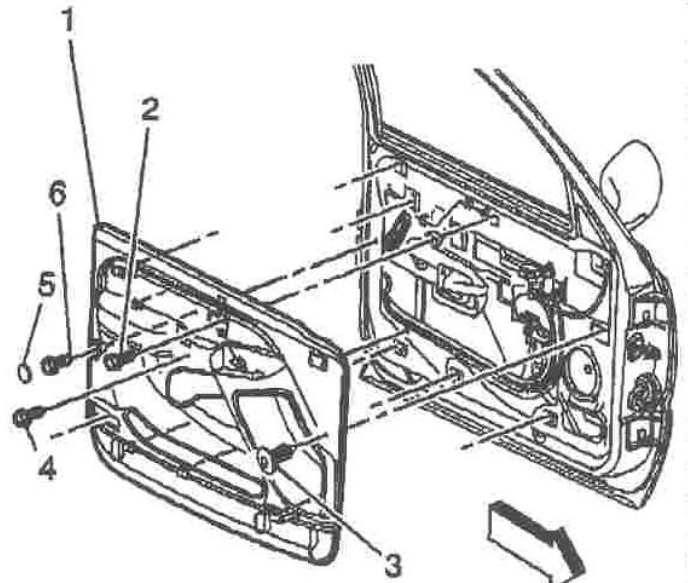

Fig. D-1

LIMITED WARRANTY

Putco guarantees its Stainless Steel and Aluminum products against defects in workmanship and material for as long as you own your vehicle. Black products have a 90-day warranty on the painted surface. Any defects resulting from faulty material or workmanship will be warranted by Putco and repaired or replaced at our discretion. Putco assumes no extra labor costs. Damages caused by freight carriers, improper installation, misuse, collision, or neglect will not be warranted by Putco.